

NO. RBT151/25RY
 SUPSDS.

QTY	PRODUCT	NEXT ASSY. DWG.	NO.	DESCRIPTION OF CHANGE	SCO	DATE	BY
				NEW ISSUE		07/26/13	DSE

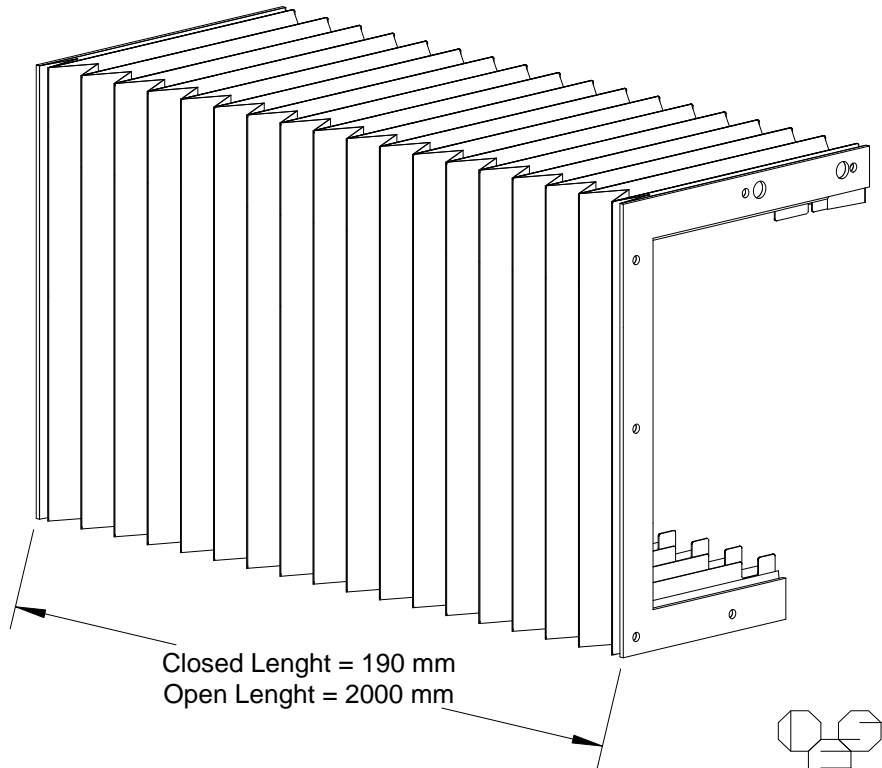
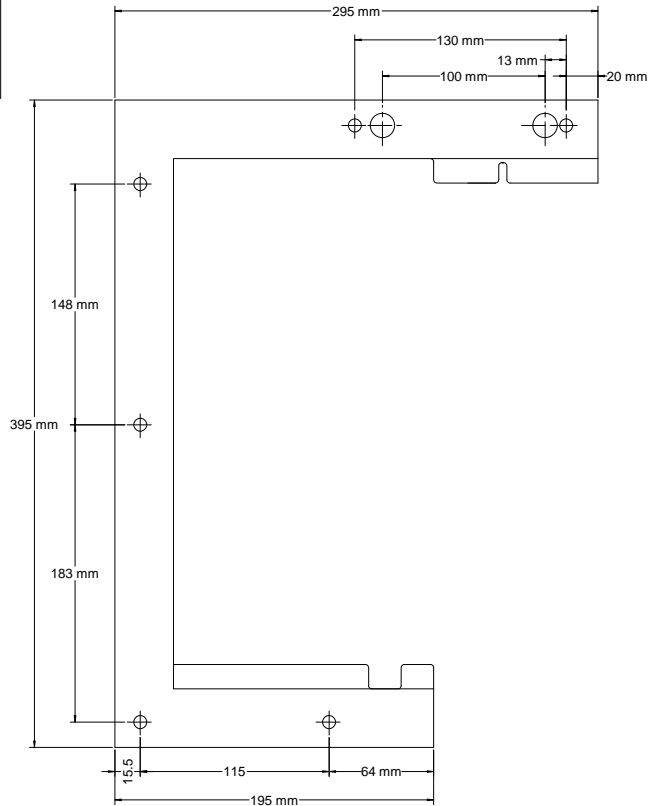
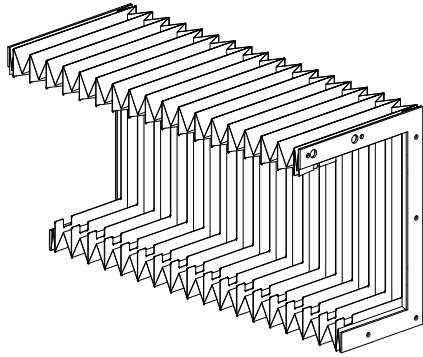

TOLERANCES UNLESS OTHERWISE SPECIFIED			
FRACTIONS $\pm 1/64$		DECIMALS: .X $\pm .1$.XXX $\pm .005$	
ANGLES $\pm 1/2^\circ$.XX $\pm .0000$ $\pm .001$	
DO NOT SCALE DRAWING			
DRAWN	DSE	SCALE	NTS
ENG. MGR.		ENG. CHKD.	
ENG. MGR.		PRODN. APPD.	
MAT'L			
MAT'L SPEC. NO.			
FINISH		PROD.	

THIS DOCUMENT IS THE PROPERTY OF RICHARDSON ELECTRONICS, LTD. AND SHALL NOT BE COPIED, REPRODUCED, USED IN THE MANUFACTURE OR SALE OF APPARATUS OR DISCLOSED TO OTHERS WITHOUT PERMISSION.

 Richardson Electronics, Ltd.

**Y RAIL BELLOWS
 REPLACES TRUMPF
 P/N 0105757**

NO. RBT151/25RY REV. 0